



Femur Condylar Plate System Procedural Steps



Table of Contents

Introduction.....	3
Instrumentation Set	8
Procedural Steps:	12
Ordering Information.....	19

Introduction

The CarboFix™ Implants

The **CarboFix™** Femur Condylar Plate System is made of longitudinal continuous carbon fibers reinforced Polymer (PEEK).

The Carbon Fibers are arranged in a unidirectional longitudinal orientation, as well as in a diagonal orientation, allowing multidirectional strength in all planes.

CarboFix™ is the first implant line to obtain FDA and CE clearance for orthopedic trauma implants made from carbon fiber composite material.

The Advantages of CarboFix™ Implants

Modulus of Elasticity

The **CarboFix™** implants are made from an innovative biomaterial "*PEEK-OPTIMA Ultra-Reinforced*" which has a modulus of elasticity which is comparable to that of cortical bone, lowering the risk for stress risers and secondary fractures.

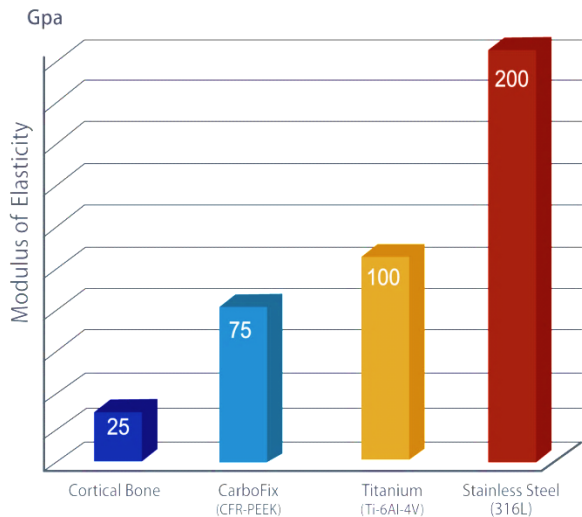

Fatigue Strength

Composite materials are known for their significant fatigue strength. Carbon fiber composite materials are currently being used in critical load bearing structures of commercial airliners (e.g. the wings of the Boeing 787 “Dreamliner”), high performance automobiles and now orthopedic trauma implants.

During fatigue testing the **CarboFix™** Femur Plate withstood 4 million cycles without showing any sign of failure or damage to the nail, which is 4 times the acceptance criteria for the applicable standard.

Radiolucency

CarboFix™ implants allow for unparalleled intraoperative and post operative imaging.

CT & MRI Imaging

The CarboFix™ implants enable CT and MRI scans with minimal artifacts interference allowing for clear images of the surrounding tissues and the bone. This is clearly an advantage in monitoring fracture healing and pathological tissue.

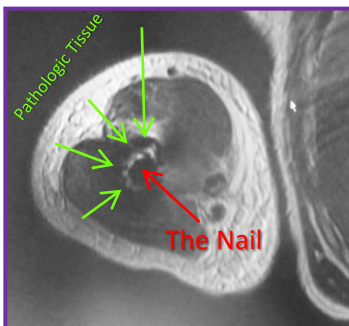

Metal Plate



Titanium Rod Ø5mm in MRI field: demonstrates massive artifacts

CarboFix™ palteview of the fracture

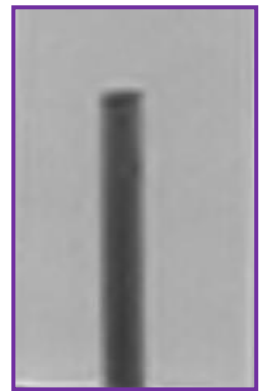

Carbon Fibers Rod Ø5mm in MRI field: no artifacts

Distal Femur Condylar Plate System Design

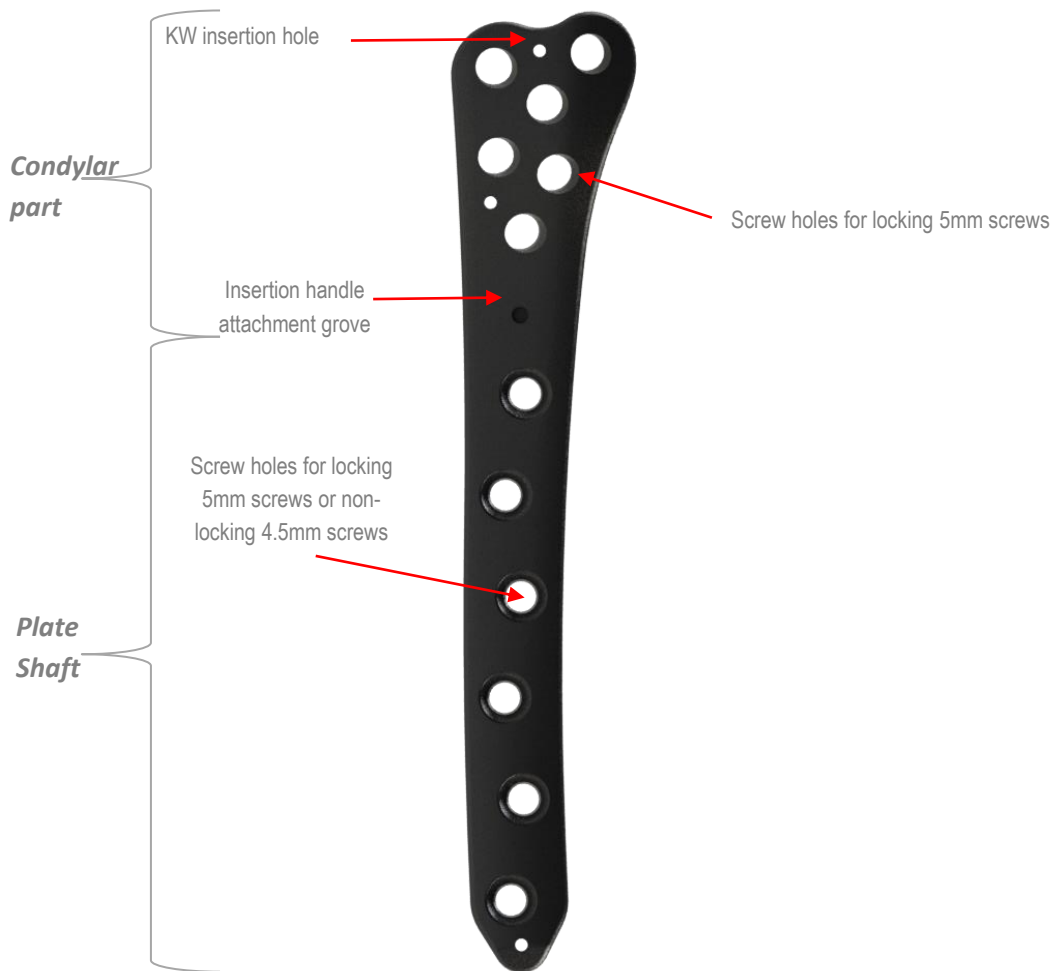

The **CarboFix™** Femur Condylar Plate system:

- Is indicated for buttressing multifragmentary distal femur fractures including supra-condylar, intra-articular and extra-articular condylar fractures, periprosthetic fractures, fractures in normal or osteopenic bone, nonunions and malunions.
 - Is anatomically contoured:
 - The Femur Condylar Plate arches to match the sagittal anatomy of the femoral shaft .
 - The articular end is shaped to match the contour of the lateral condial .
 - Circumference radiopaque marking outlining the plate contour for positioning & follow-up
 - Compatible plate shaft Screw Holes for locking or non-locking screws
 - Similar instrumentation & procedure steps as conventional metal plates
- * For further information please refer to the product instructions for use.

The Implants

The Plates are supplied sterile in different diameters & lengths:

Femur (Left/Right)

Length (mm)	Holes (Shaft)	Shaft Width (mm)	Articular Width Max. (mm)	Thickness (mm)
171	6	17.5	33	5.1
207	8			
243	10			
279	12			
315	14			
351	16			

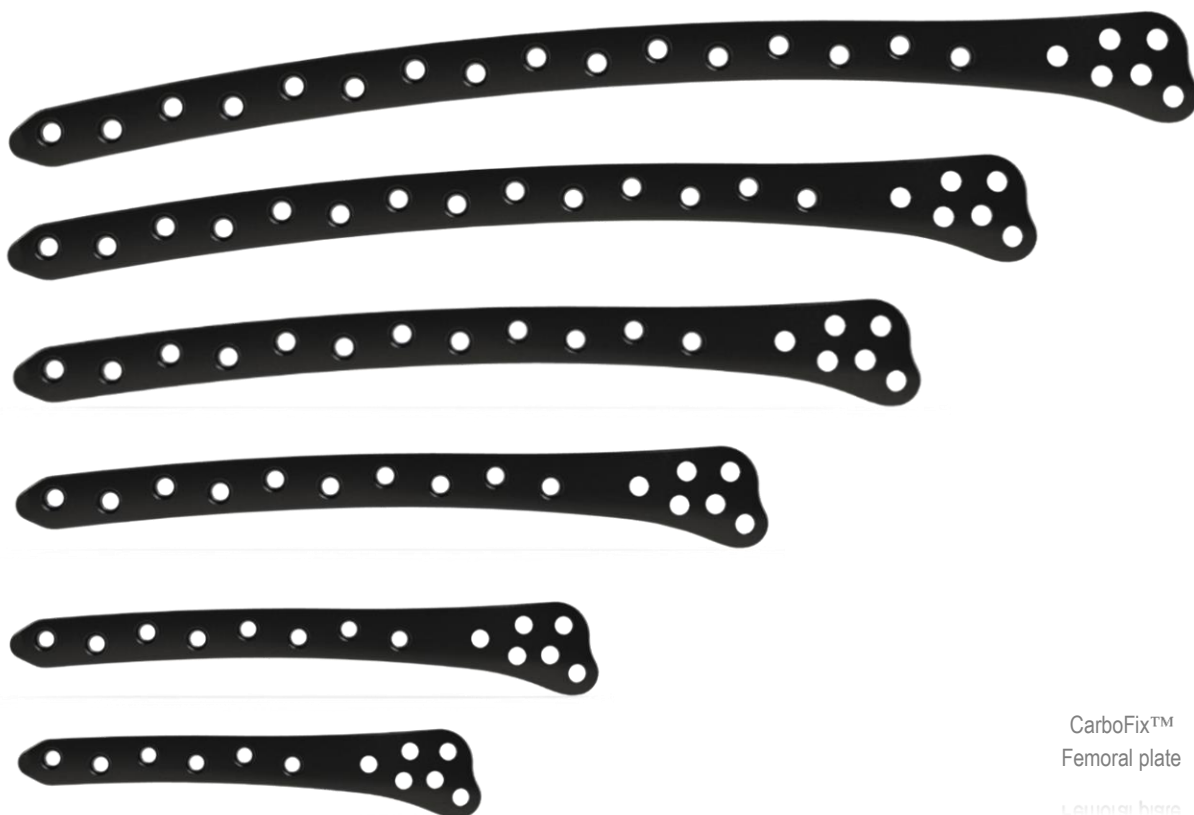

The Screws

Proprietary self-tapping titanium screws are used to fixate the plate:

All screws are provided non-sterile and are contained in the instrument tray.

Description	Diameter (mm)	Lengths (mm)	Screw Color	Drill Bit Diameter (mm)
Locking Screws	5.0	20-55 (2.5 increments) 55-90 (5 increments)	Green 	4.3mm
Uncortical Locking-Screws	5.0	10-18 (2increments)	Green 	4.3mm
Non-Locking Screws Shaft Only	4.5	22.5-55 mm (2.5 increments) 55-70 (5 increments)	Yellow 	3mm

** All Screws can be angled anywhere up to 30° cone around each hole central axis

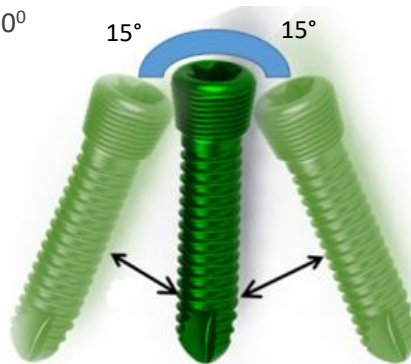

Instrumentation Set

Metal Plate Template

The metal plate template is used to determine the desired plate length.



Insertion Handle

The insertion handle is mounted on the plate at the dedicated insertion handle hole. The device facilitates sub muscular, introduction of the plate. left (A) and right (B) insertion handle are available for left and right plates.



Insertion Handle bolt

The handle bolt is inserted via a dedicated slot in the handle. And attaches the handle to the plate at the proximal condylar hole.



Aiming Arm

The aiming arm attaches to the insertion handle. It is an aiming adjunct for minimal invasive exposure. The device facilitates drilling of the shaft holes and inserting the screw percutaneously. once assembled, the arm holes are aligned with the plate holes.

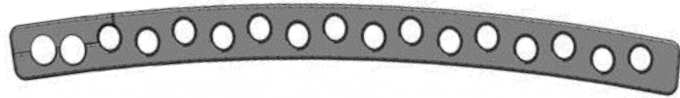

The aiming arm is available in two lengths :

16 Holes, and 10 holes- to be used with matching plates.



Aiming Arm Connecting Bolt

The aiming arm connecting bolt fastens the aiming arm to the insertion handle. It is inserted at the proximal hole.



Ø2.0 mm K-Wire

The Ø2.0X300mm K-Wire assists the surgeon in positioning the plate, as well as in fracture reduction. X5

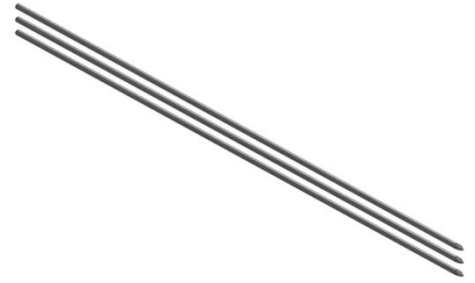

Free Hand Drill Sleeve Ø4.3 mm

The Free Hand Drill Sleeve is used for drilling the holes for non-locking screws at the plate shaft, using the Ø4.3mm Drill Bit.

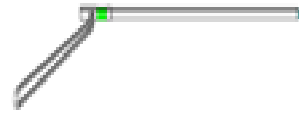

Reduction device

A pointed reduction clamp, and a pate holder are supplied

Targeting Guide Sleeves

There are 2 Targeting Guide Sleeves and a Trocar:

- **Targeting Guide Sleeve** (Ø10/8mm) - inserted into the Aiming arm designated holes (A).
- **Targeting Guide Drill Sleeve** (Ø8/4.3mm) - inserted into the Targeting Guide Sleeve (B).
- **Trocar** (Ø4.3mm) - inserted into the Targeting Guide Drill Sleeve (C).

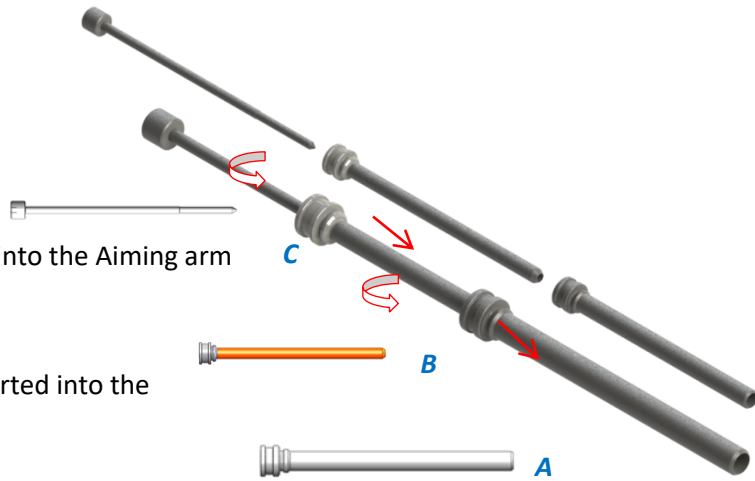

The Sleeves are threaded and lock into each other.

Two sets of sleeves are supplied.



K-Wire Sleeve 2.0mm- inserted via the targeting Guide drill sleeve and facilitates Proximal stable locking of the aiming arm to the plate.

K-Wire Sleeve Handle

Connects to the K-Wire sleeve



Drill Bits Ø4.3, Ø3.0

Two different Drill Bits are available:

- **Ø4.3x300mm**: For drilling the locking screws. For drilling the plate locking screws.
- **Ø3.0x300mm**: For drilling the Non-locking screws (Marked Yellow).



Depth Gauge

The Depth Gauge assists in determining the desired screw length.



Screwdriver Handle

It is used to screw screws, and bolts.

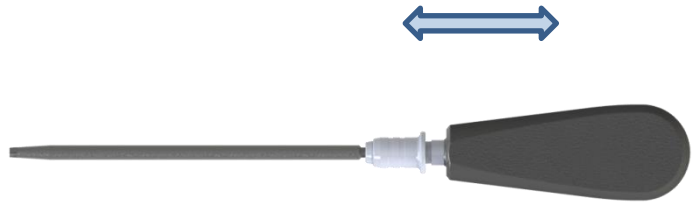

Screwdriver shaft

For use with a power drive, or screwdriver handle.



Procedure Steps

1. Expose the bone according to routine surgical technique. Reduce the fracture , using sharp reduction clamp. K-Wire may be used for temporary fixation. Confirm fracture reduction via fluoroscopy. Determine the required plate length using the plate templates. This may be obtained directly or via fluoroscopy.

2. Chose a correct insertion handle (Left or Right). Align the handle with the plate and insert the connection bolt via the proximal connection slot .

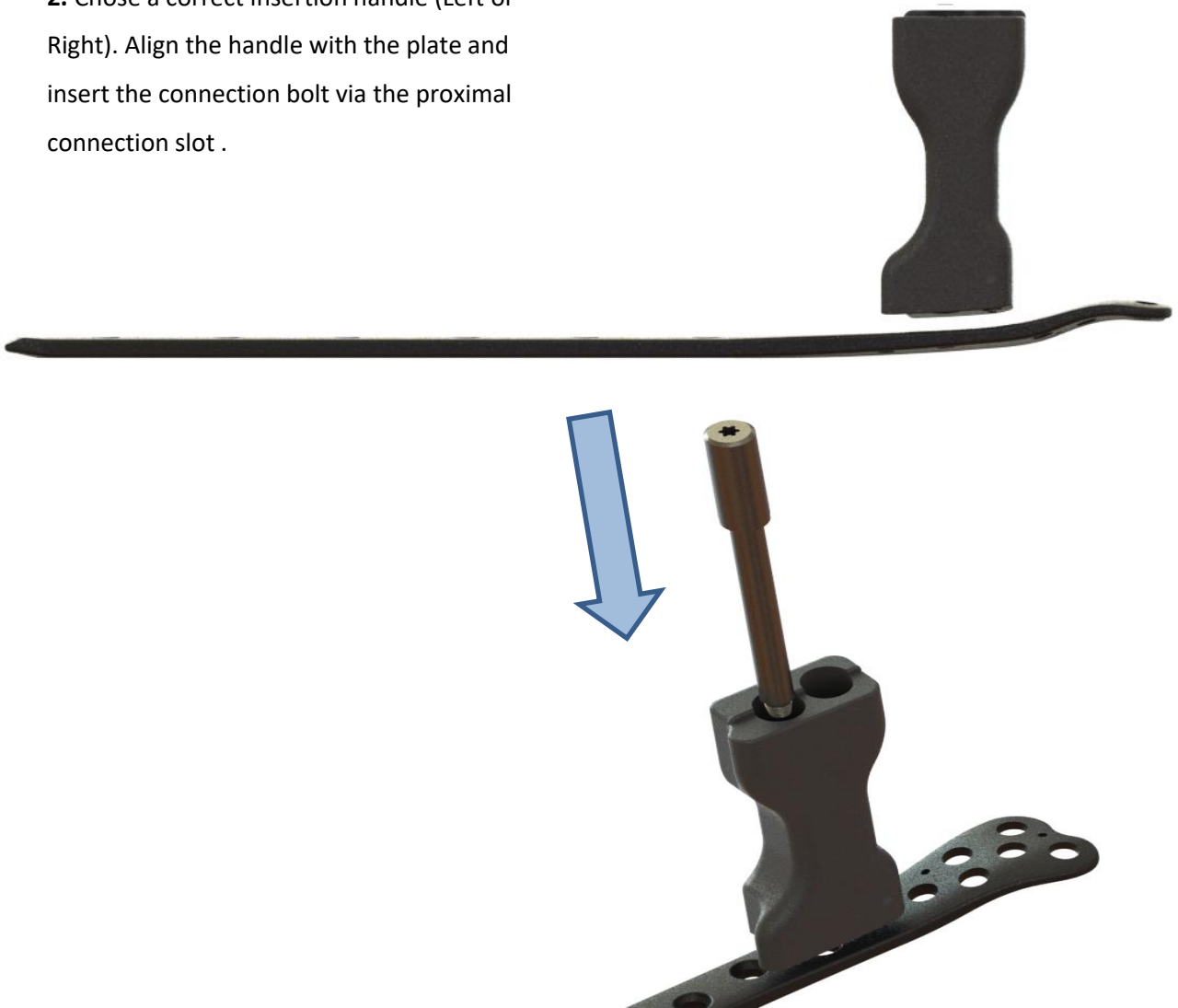

Procedure Steps

3.; position the handle inserting the connection pin (A) to the designated connection groove (B).

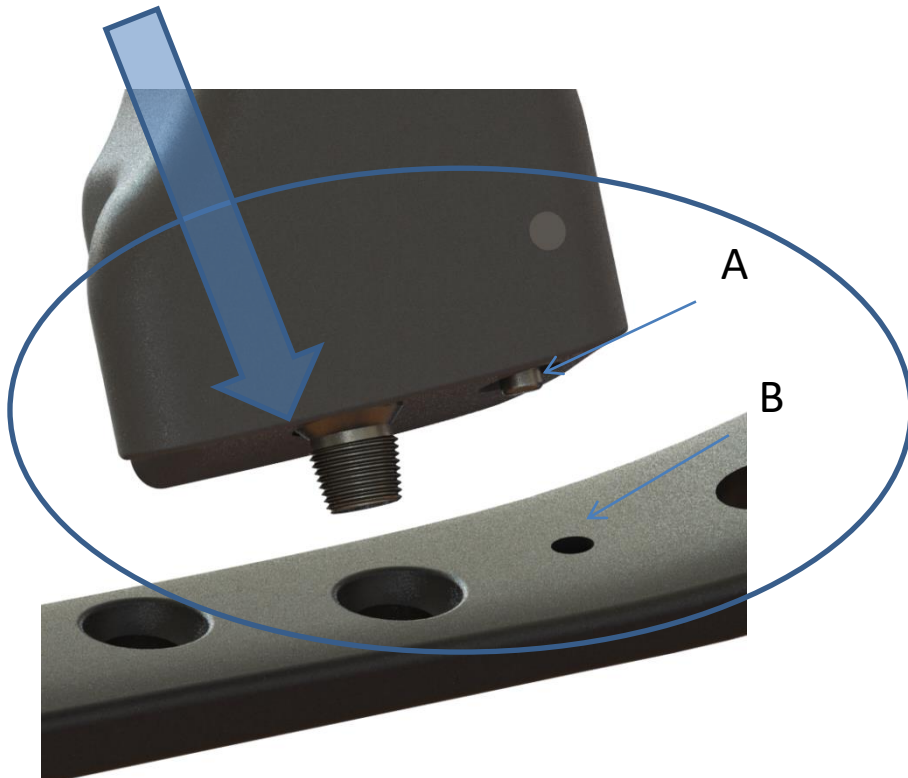

Procedure Steps

4. Fasten the connection bolt via the proximal connection slot. Use the Screwdriver to secure the bolt to the plate, by screwing the connection Bolt into the distal shaft hole on the plate.



5. Insert the Plate over the bone distal to proximal. Align the condylar area with the lateral femoral condial. Plate positioning may be assisted by inserting a K-Wire.



6. Assemble the aiming arm; Place the aiming arm over the handle in the proper orientation (arm curvature should line with the plate). Attach the aiming arm to the insertion handle by inserting the aiming arm connecting bolt at the proximal hole (A) and fastening it to the insertion handle.

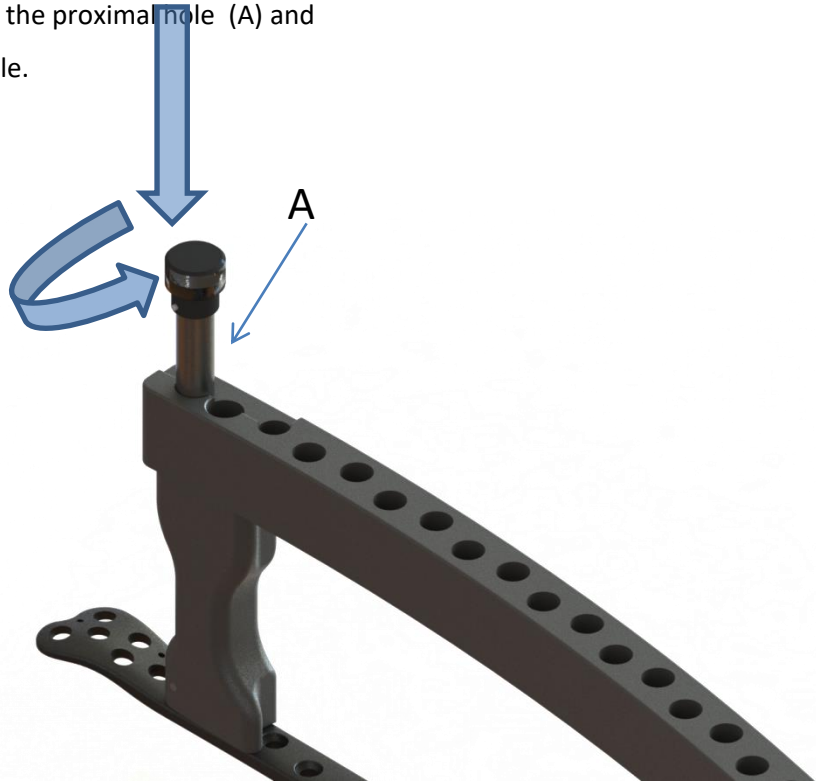

**Either proximal or distal screws can be inserted first , in accordance to surgeons discursion and fracture type.

Proximal Screws

7. Insert the Drill Sleeve into the Guide Sleeve and lock it by rotating i clock wise (B). Insert the Trocar (C).

Incise the skin where proximal interlocking holes are located, and place the Assembly into the appropriate Handle hole .

Remove the trocar and drill sleeve . Insert the K-Wire Sleeve 2.0mm and fasten it to the plate. Alien the plate with the femur and insert 2.0mm K (optional).

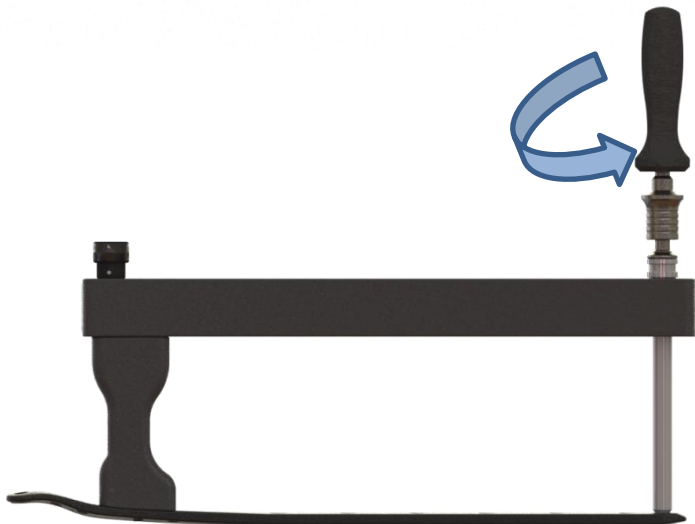
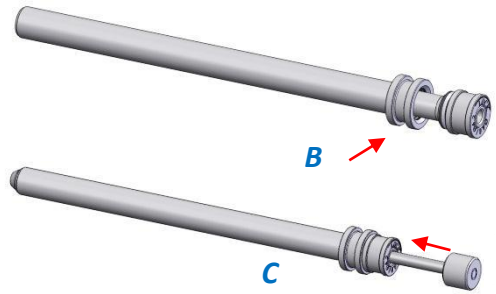

Proximal Screws

8. Drilling:

Either Locking or non-locking Proximal screws may be used according to the surgeon's discretion.

For drilling holes for the Proximal Locking Screws ($\varnothing 5.0\text{mm}$, **Green**) use the **4.3x300mm** Drill Bit marked **Green(A)**.

For drilling holes for the Proximal Non-Locking Screws ($\varnothing 4.5\text{mm}$, **Gold**) use the **3.0 x300mm** Drill Bit marked **Gold**.

Ensure that the Drill Sleeve tip is touching the cortex, and measure the desired Screw length by using the markers on the Drill Bit. Alternatively, the Depth Gauge can be used by inserting it into the Guide Sleeve.

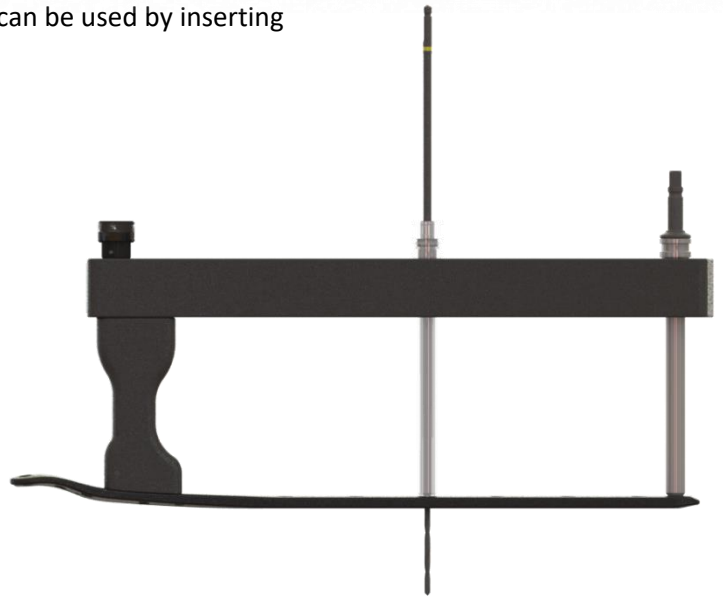

9. Remove the Drill Bit and its Sleeve.

Using the Screwdriver, insert a Screw the plate.

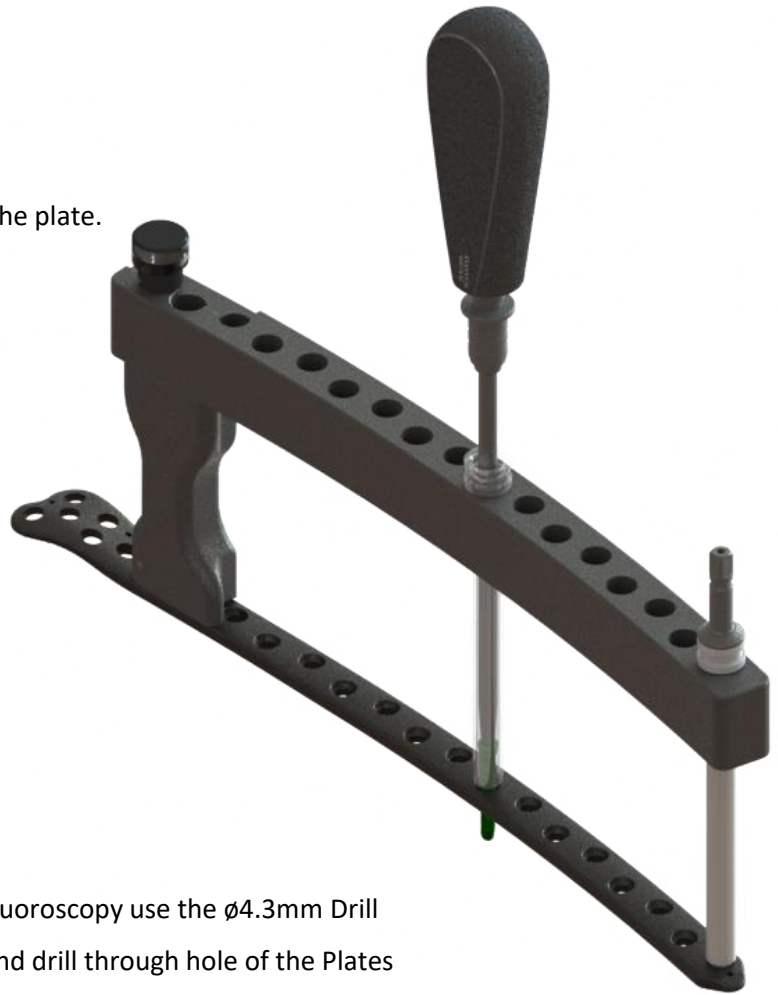

10. Condylar screws placement: Under fluoroscopy use the $\varnothing 4.3\text{mm}$ Drill Bit, through the Free Hand Drill Sleeve, and drill through hole of the Plates condylar part (poly-axial). Verify that the trajectory passes at least 5–8mm below the joint surface. Determine the required locking Screw length using the Depth Gauge. Insert the Screw using the Screwdriver. Verify placement under X-ray.

11. Place the rest of the shaft and condylar screws. Verify placement under X-ray.

12. Remove k-wire sleeve, insert the drill sleeve, drill shaft proximal hole and insert screw

11. Remove the Targeting Guide, and close the incision according to routine surgical procedure.

**** Do not apply high torque when tightening the screw; excessive torque may damage the bone or implant.***

Ordering Information











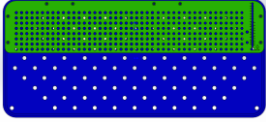





Plates

Cat No.	Description	No. of holes (Shaft)	Length (mm)	Right / Left
DFELN1806	CarboFix Distal Femur Plate 6/L	6	171	Left
DFELN1808	CarboFix Distal Femur Plate 8/L	8	207	Left
DFELN1810	CarboFix Distal Femur Plate 10/L	10	243	Left
DFELN1812	CarboFix Distal Femur Plate 12/L	12	279	Left
DFELN1814	CarboFix Distal Femur Plate 14/L	14	315	Left
DFELN1816	CarboFix Distal Femur Plate 16/L	16	351	Left
DFERN1806	CarboFix Distal Femur Plate 6/R	6	171	Right
DFERN1808	CarboFix Distal Femur Plate 8/R	8	207	Right
DFERN1810	CarboFix Distal Femur Plate 10/R	10	243	Right
DFERN1812	CarboFix Distal Femur Plate 12/R	12	279	Right
DFERN1814	CarboFix Distal Femur Plate 14/R	14	315	Right
DFERN1816	CarboFix Distal Femur Plate 16/R	16	351	Right

Ordering Information

Screws

No.	DESCRIPTION	QTY.	CATALOGUE NO.
1.	Non- Locking Screw 4.5x22.5mm	6	PTCST45225
2.	Non- Locking Screw 4.5x25.0mm	6	PTCST45250
3.	Non- Locking Screw 4.5x27.5mm	6	PTCST45275
4.	Non- Locking Screw 4.5x30.0mm	8	PTCST45300
5.	Non- Locking Screw 4.5x32.5mm	8	PTCST45325
6.	Non- Locking Screw 4.5x35.0mm	8	PTCST45350
7.	Non- Locking Screw 4.5x37.5mm	8	PTCST45375
8.	Non- Locking Screw 4.5x40.0mm	8	PTCST45400
9.	Non- Locking Screw 4.5x42.5mm	6	PTCST45425
10.	Non- Locking Screw 4.5x45.0mm	4	PTCST45450
11.	Non- Locking Screw 4.5x47.5mm	4	PTCST45475
12.	Non- Locking Screw 4.5x50.0mm	4	PTCST45500
13.	Non- Locking Screw 4.5x52.5mm	4	PTCST45525
14.	Non- Locking Screw 4.5x55.0mm	4	PTCST45550
15.	Non- Locking Screw 4.5x60.0mm	4	PTCST45600
16.	Non- Locking Screw 4.5x65.0mm	4	PTCST45650
17.	Non- Locking Screw 4.5x70.0mm	4	PTCST45700
18.	Locking Screw 5.0x20.0mm	6	PLCST50200
19.	Locking Screw 5.0x22.5mm	6	PLCST50225
20.	Locking Screw 5.0x25.0mm	6	PLCST50250
21.	Locking Screw 5.0x27.5mm	6	PLCST50275
22.	Locking Screw 5.0x30.0mm	8	PLCST50300
23.	Locking Screw 5.0x32.5mm	8	PLCST50325
24.	Locking Screw 5.0x35.0mm	8	PLCST50350
25.	Locking Screw 5.0x37.5mm	8	PLCST50375
26.	Locking Screw 5.0x40.0mm	8	PLCST50400
27.	Locking Screw 5.0x42.5mm	6	PLCST50425
28.	Locking Screw 5.0x45.0mm	4	PLCST50450
29.	Locking Screw 5.0x47.5mm	4	PLCST50475
30.	Locking Screw 5.0x50.0mm	4	PLCST50500
31.	Locking Screw 5.0x52.5mm	4	PLCST50525
32.	Locking Screw 5.0x55.0mm	4	PLCST50550
33.	Locking Screw 5.0x60.0mm	4	PLCST50600
34.	Locking Screw 5.0x65.0mm	4	PLCST50650
35.	Locking Screw 5.0x70.0mm	4	PLCST50700
36.	Locking Screw 5.0x75.0mm	4	PLCST50750
37.	Locking Screw 5.0x80.0mm	4	PLCST50800
38.	Locking Screw 5.0x85.0mm	4	PLCST50850
39.	Locking Screw 5.0x90.0mm	4	PLCST50900
40.	Unicortical Locking Screw 5.0x10.0mm	4	PUCST50100
41.	Unicortical Locking Screw 5.0x12.0mm	4	PUCST50120
42.	Unicortical Locking Screw 5.0x14.0mm	4	PUCST50140
43.	Unicortical Locking Screw 5.0x16.0mm	4	PUCST50160
44.	Unicortical Locking Screw 5.0x18.0mm	4	PUCST50180

NO.	DESCRIPTION	QTY.	CATALOGUE NO.	PICTURE
1.	Sterilization Box	1	DF930005	
2.	Handle Left	1	DF930010	
3.	Handle Right	1	DF930310	Similar to Handle Right
4.	Aiming Arm – 16 Holes	1	DF930020	
5.	Aiming Arm – 10 Holes	1		
6.	Handle Screw	1	DF930140	
7.	Connection Screw	1	DF930150	
8.	Sleeve Ø10/8mm	3	DF930030	
9.	Drill Sleeve Ø8/4.3mm	1	DF930040	
10.	Trocar Ø4.3mm	1	DF930050	
11.	Drill Bit Ø4.3x300mm	1	DF930060	
12.	Drill Bit Ø3.0x300mm	1	DF930070	
13.	Screwdriver Rod T25 Long	2	DF930080	
14.	Screwdriver Handle	2	PL921820	
15.	K-Wire Ø2.0X300mm	5	DF930090	
16.	K-Wire Sleeve 2.0mm	1	DF930160	
17.	K-Wire Sleeve Handle	1	DF930170	
18.	Depth Gauge Distal Femur	1	DF930100	
19.	Free Hand Drill Sleeve	1	DF930110	
20.	Forceps Pointed Tip	1	PL921790	Standard Item
21.	Bone Holding Forceps	1	PL921890	Standard Item
22.	Template 16 Holes Left	1	DF930300	



www.carbo-fix.com

For detailed procedure, indications, contraindications, possible adverse event, warnings and precautions, refer to the Instructions for Use
Caution: In the U.S.A., federal law restricts this device to sale by or on the order of a physician.

MANUFACTURED BY:

CarboFix Orthopedics Ltd.
11 Ha'hoshlim St.,
Herzeliya 46724 , Israel
Tel: +972-9-9511511
Fax: +972-9-9548939
E-Mail: info@carbo-fix.com

U.S.A. OFFICE:

CarboFix Orthopedics Inc.
9983 Traders Lane, Ext. 1
Calabash NC 28467
USA
Tel: 1-800-408-0120
E-Mail: usa@carbo-fix.com

EC AUTHORIZED REPRESENTATIVE:

MEDNET EC-REP IIb GmbH
Borkstrasse 10, 48163 Münster
Germany

Patents are pending



0483